

# Medical Halakha Update in honor of TIM'S Bar Mitzvah



Rabbi Edward Reichman, M.D.  
Professor, Emergency Medicine  
Professor, Education and Bioethics  
Albert Einstein College of Medicine

# LEARNING OBJECTIVES

1. At the conclusion of this presentation, participants will be able to appreciate the Jewish approach to modern medical advances.
2. At the conclusion of this presentation, participants will be able to identify some major medical developments over the last thirteen years.
3. At the conclusion of this presentation, participants will be able to properly celebrate and appreciate TIM's (Torah in Motion) Bar Mitzvah.

# Born in 2009

Already precocious and ahead of your time

## 2009

1. Scarce resources and economics of health care
2. Pandemic planning
3. Stem cell research
4. Cloning in Halacha
5. Surrogate mothers
6. Euthanasia in Halacha

# Maternity and Paternity: Issues and Challenges 2010 Lake Placid

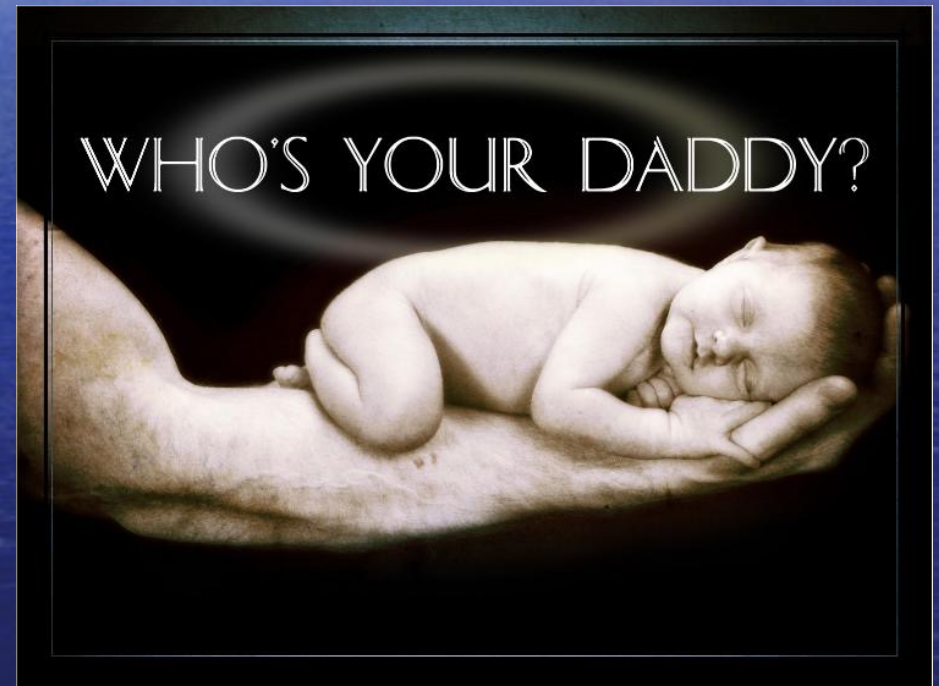
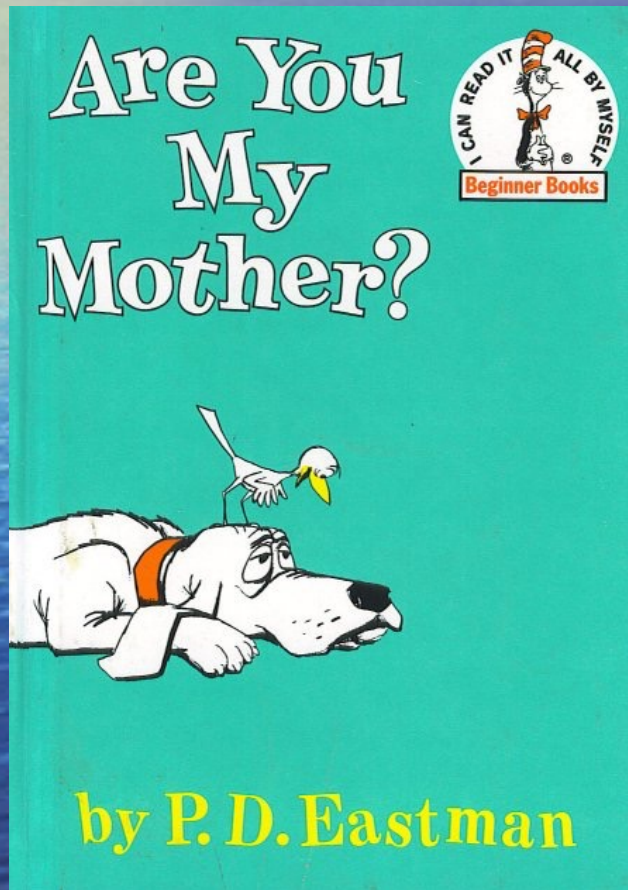

Rabbi Edward Reichman, M.D.  
Associate Professor, Emergency Medicine  
Associate Professor, Bioethics and Education  
Albert Einstein College of Medicine  
Yeshiva University

# Maternity in Assisted Reproduction: Halakhic issues 2010 Lake Placid

- **Mitzvot**
  - Pru urvu
  - **Kibud av v'aim**
  - Pidyon haben
- **Personal status**
  - **Nationality**
  - **Marriagability (e.g., mamzer)**
  - **Prohibited marriages**
  - **Yibum**
  - **Family lineage (yichus)**
- **Civil Law**
  - **Inheritance (including first born status and inheritance)**
  - **Child financial support**

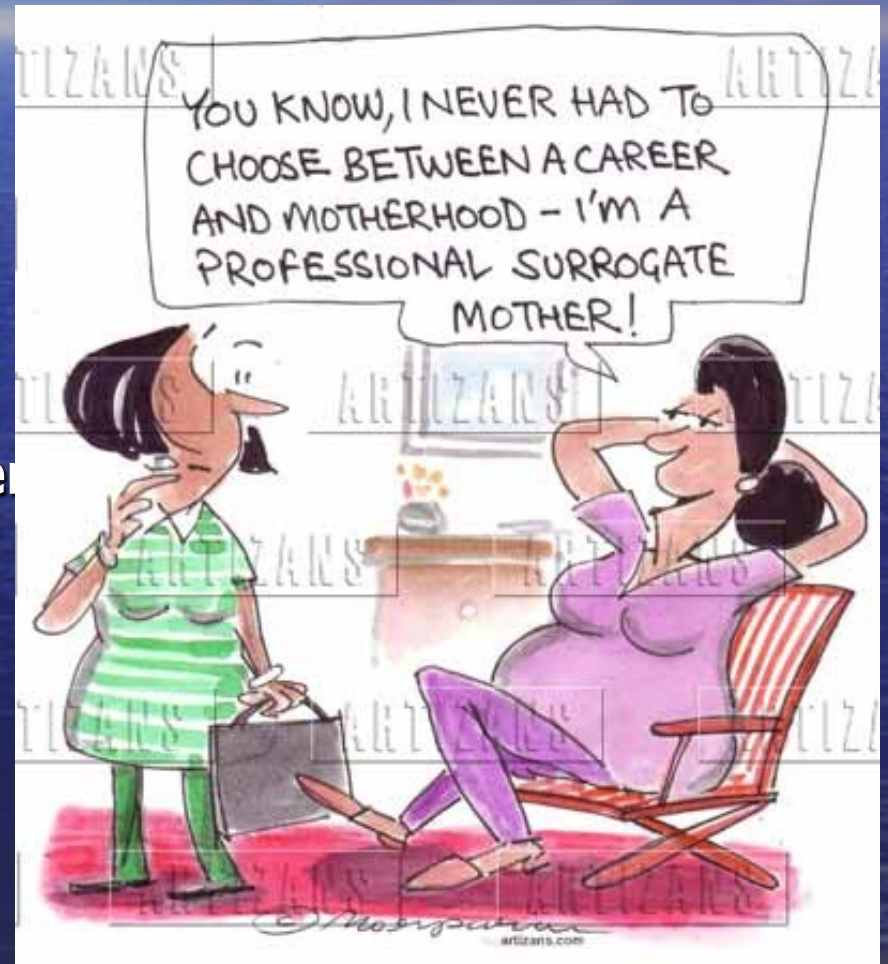

# Artificial Reproductive Seed Lake Placid 2010

Human Reproduction Vol.21, No.4 pp. 857-863, 2006  
Advance Access publication December 16, 2005.

doi:10.1093/humrep/dci430

## OPINION

### Embryonic stem-cell gametes: the new frontier in human reproduction

Zubin Master

**HOW THE CELLS ARE GROWN**

**1** Stem cells are taken from infertile male's bone marrow.

**2** They are then cultivated in a chemical soup that turns them into sperm cells.

**3** The sperm cells could then be transplanted into the patient's testes or if allowed to develop further, used to fertilise eggs in IVF treatment.

**STEM CELLS:** These are blank cells which have the power to turn into other cell types, creating a 'repair kit' for the body.

Professor Nayernia (left), who carried out the research.



frontiers

in Bioengineering  
and Biotechnology

Bioprocess Engineering

SECTION

ABOUT

ARTICLES

RESEARCH TOPICS

FOR AUTHORS

EDITORIAL BOARD



ARTICLE ALERTS

< Articles

THIS ARTICLE IS PART OF THE RESEARCH TOPIC  
Stem Cell Systems Bioengineering [View all 15 Articles](#) >

REVIEW article

Front. Bioeng. Biotechnol., 22 July 2020 | <https://doi.org/10.3389/fbioe.2020.00781>



# Generation of Artificial Gamete and Embryo From Stem Cells in Reproductive Medicine

Pu-Yao Zhang<sup>1,2</sup>, Yong Fan<sup>3</sup>, Tao Tan<sup>1,4\*</sup> and Yang Yu<sup>1,2\*</sup>

Gametes from embryonic and adult stem cells  
Creating embryos from stem cell

NEWS | 11 September 2019 | Correction 16 September 2019

# Embryo-like structures created from human stem cells

New method makes it easier to create structures to model early human development, but raises ethical issues.

David Cyranoski

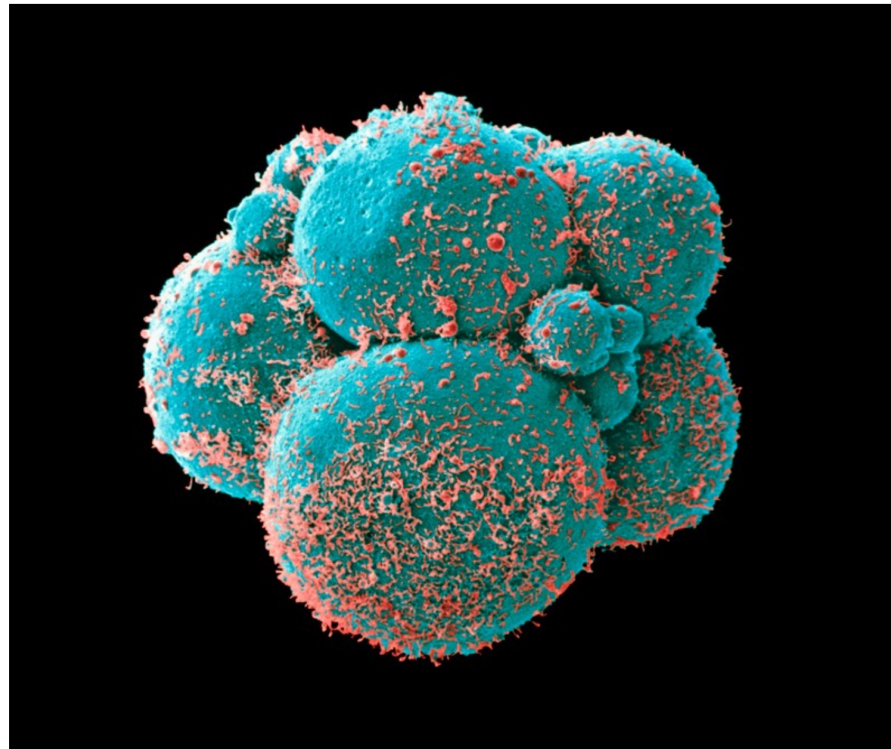

An early human embryo. Structures with similar features could be used to study human development. Credit: Dr Yorgos Nikas/SPL

Biologists have developed a way to use human stem cells to make structures that mimic early embryos. The embryo-like structures are the first to produce rudimentary



שלומי רייסקין

## הפרייה באמצעות "זרע מלאכותי"

ראשי פרקים:

- א. זרע מלאכותי
- ב. שיקולים הלכתיים  
קביעת אבהות  
מצוות פרו ורבו  
ייצור זרע ממח עצמות של נפטר  
וקדשתו  
פדיון בכור וירושתו  
ממזרות – קרבת משפחה בין תורם למופרית  
הכשר ממזרים ופסולי חיתון  
ייבום  
עילה לגירושין
- ג. סיכום

# 2010 Lake Placid- Ectogenesis

**BABIES OF THE FUTURE**

**ECTOGENESIS**  
Producing babies outside the mother's body, in the laboratory. A mother could work right through her "pregnancy"—because she wouldn't be carrying the baby.

**CLONING**  
Churning out identical copies of humans. The danger is that the rich and powerful could run off copies of themselves. Imagine a million-strong army of Hitlers!

**FARMING WOMEN**  
Dosing women with hormones to stimulate them into multiple ovulation and storing eggs for breeding future generations— one woman produced 44 eggs at one go.

**GENETIC ENGINEERING**  
Tailoring future offspring to any specifications: color, height, size, intelligence, strength.

Graphic by TONY SELA

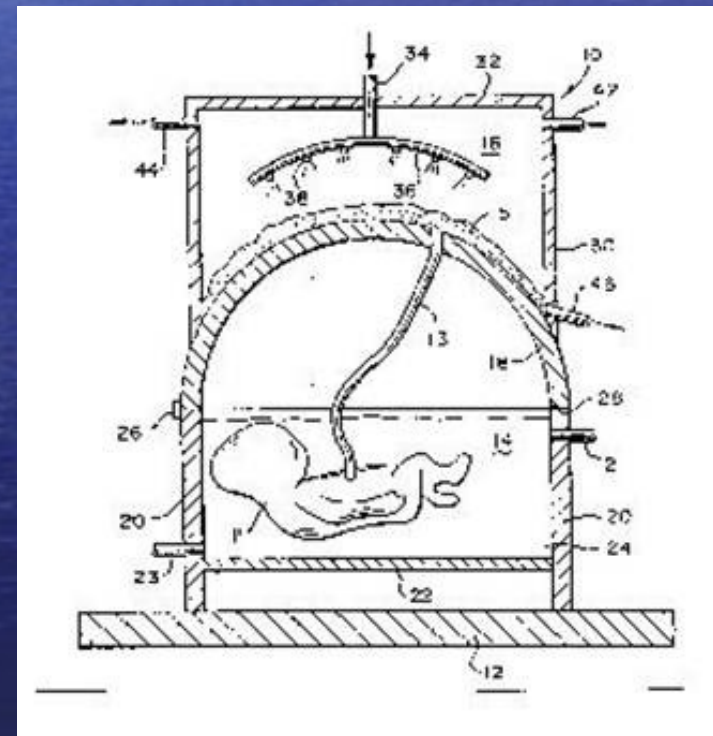
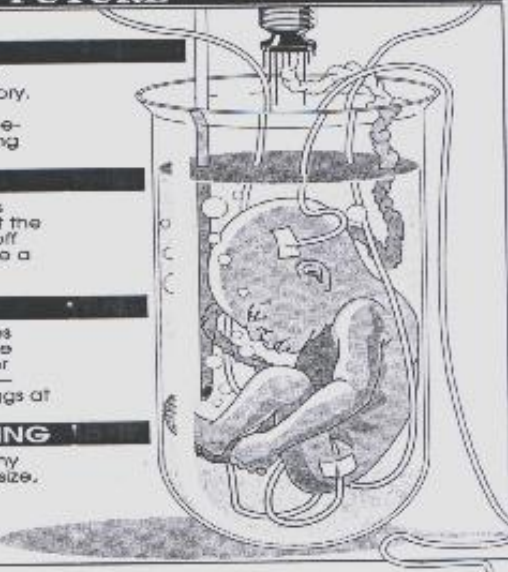

# 2015 Bushkill



**R' Ralbag, Ateret Shlomo 8(5763)**

## **The Artificial Womb Is Born: Welcome To The World Of The Matrix** Feb 16, 2015

The artificial womb exists. In Tokyo, researchers have developed a technique called EUFI — extrauterine fetal incubation. They have taken goat fetuses, threaded catheters through the large vessels in the umbilical cord and supplied the fetuses with oxygenated blood while suspending them in incubators that contain artificial amniotic fluid heated to body temperature.

עובר שהתפתח באינקובטור עד  
ליצירת הולד, מה דינו של הולד

בתורת הרפואה ישנה נוסחה המאפשרת  
ליצור עובר מביצית שהופרתה  
ללא צורך בהשתלת הביצית בתוך גוף של  
אשה, אלא בתוך אינקובטור שקיימים בו  
תנאים הזוהים לרחם אשה. באינקובטור זה  
מתפתח העובר משלב ההתחלה שהיתה  
קיימת הביצית שהופרתה עד לשלב הסופי  
שהוא יצירתו של עובר שלם ויציאתו  
לאויר העולם.

נשאלת השאלה במקרה זה למי מתייחס  
הולד, הרי הוא לא נולד מאשה,  
התשובה היא שלולד זה אכן אין אם ואינו  
מתייחס לבעלת הביצית שהוא נוצר ממנה  
ישרון דינו לא נולד ממנה הממנה

# 2017 Montreal Ectogenesis

## Scientists Create Artificial Womb That Could Help Prematurely Born Babies

Scientists have created an "artificial womb" in the hopes of someday using the device to save babies born extremely prematurely. So far the device has only been tested on fetal lambs. A [study](#) published Tuesday involving eight animals found the device appears effective at enabling very premature fetuses to develop normally for about a month.

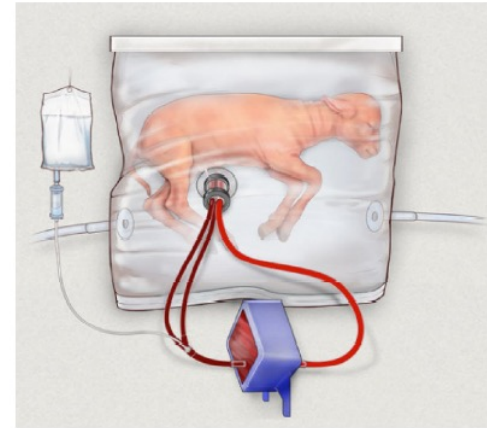

## Scientists grow mouse embryos in mechanical womb

March 17, 2021 at 5:35 pm | Updated March 18, 2021 at 1:01 pm

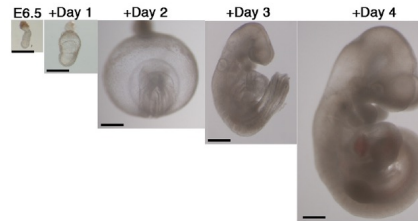

By [GINA KOLATA](#)

*The New York Times*

The mouse embryos looked perfectly normal. All their organs were developing as expected, along with their limbs and circulatory and nervous systems. Their tiny hearts were beating at a normal 170 beats per minute.

But these embryos were not growing in a mother mouse. They were developed inside an artificial uterus, the first time such a feat has been accomplished, scientists reported on Wednesday.

The experiments, at the Weizmann Institute of Science in Israel, were meant to help scientists understand how mammals develop and how gene mutations, nutrients and environmental conditions may affect the fetus. But the work may one day raise profound questions about whether other animals, even humans, should or could be cultured outside a living womb.

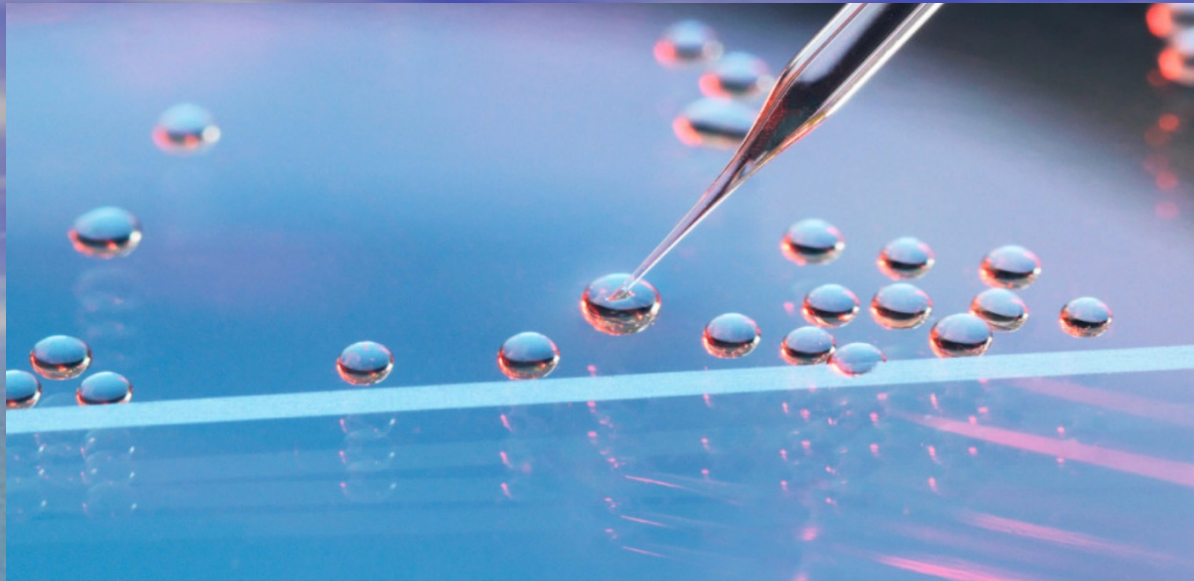

Biotechnology / Genetic engineering

---

# Scientists plan to drop the 14-day embryo rule, a key limit on stem cell research

As technology for manipulating embryonic life accelerates, researchers want to get rid of their biggest stop sign.

by **Antonio Regalado**

March 16, 2021

# Ectogenesis

- Maternity
- Definition of the Human Being
- Pidyon Haben
- Milah on Shabbos
- ? “birth” day and Bar Mitzvah parsha  
(e.g. delay decanting to avoid Matos Masei Rosh Chodesh)
- Chillul Shabbos

# A Mitochondrial Mother? Lake Placid 2010

**Embryos** created with DNA from 3 people

February 5, 2008

By MARIA CHENG, AP

British scientists say they have created human embryos containing DNA from two women and a man in a procedure that researchers hope might be used one day to produce embryos free of inherited diseases.

The process aims to create healthy embryos for couples to avoid passing on genes carrying diseases.

The genes being replaced are the mitochondria, a cell's energy source, which are contained outside the nucleus in a normal female egg. Mistakes in the mitochondria's genetic code can result in serious diseases like muscular dystrophy, epilepsy, strokes and mental retardation.

In their research, Chinnery and colleagues used normal embryos created from one man and one woman that had defective mitochondria in the woman's egg. They then transplanted that embryo into an emptied egg donated from a second woman who had healthy mitochondria.

Only trace amounts of a person's genes come from the mitochondria, and experts said it would be incorrect to say that the embryos have three parents.



# 2017 Montreal- Mitochondrial DNA

First 3-parent baby born

The NEW ENGLAND JOURNAL of MEDICINE

## CLINICAL IMPLICATIONS OF BASIC RESEARCH

Elizabeth G. Phimister, Ph.D., Editor

### Mitochondrial Donation — Clearing the Final Regulatory Hurdle in the United Kingdom

3 Parent Embryos and Mitochondrial Transfer  
**Baby born with DNA from 3 people, first from new technique** Sep. 27, 2016

NEW YORK (AP) — Scientists say the first baby

has been born from a new technique that combines DNA from three people.

The goal is to prevent the child from inheriting a fatal genetic disease from the mother.

וכך מסתבר גם בני"ד, דיש להכריע דהאם שכמעט כל החומר הגנטי מעצמה ובשרה היא האם עפ"י ההלכה והולד מתייחס אחריה.

ואף דיש מקום להתווכח ולומר דאם באנו לדמות מילתא למילתא, חרי בביטול ברוב אמרינן דדבר המעמיד לא בטל, ועוד דכל דנותן טעם איננו בטל, וכך יש לדון גם בני"ד דכיון דמעט החומר הגנטי שבקליפת הביצית יש בו מרכיב חיוני לחיי האדם והוא המעמיד אותו לא בטל.

אך באמת עיקר חילי ממה דנראה בעיני ברור ופשוט דלא יתכן כלל מבחינת ההלכה שיהיו לאדם שתי אמהות כשם שא"

## Development of mitochondrial replacement therapy: A review

Hitika Sharma,<sup>a</sup> [Drishtant Singh](#),<sup>b</sup> [Ankush Mahant](#),<sup>c</sup> [Satwinder Kaur Sohal](#),<sup>d</sup> [Anup Kumar Kesavan](#),<sup>b</sup> and [Samiksha](#)<sup>d,\*</sup>

### 7.3. Deceptive terminologies

MRT has been associated with a number of terms, some of which conveyed positive implications like “Mitochondrial gene therapy”, “Mitochondrial donation”, “Life-saving Treatment” ([Ravitsky et al., 2015](#)), “Narratives of Hope” ([Herbrand and Dimond, 2017](#)) while some others made negative impacts like “Three parent baby”, “Three-person baby”, “Three persons DNA” ([Gonzalez-Santos et al., 2018](#)), “Slippery Slope” ([Carr, 2015](#)), “Designer babies” ([Kaur and Nagpal, 2017](#)). As stated the term third parent name given to mitochondrial donor is highly misleading and non-sense ([Dimond and Stephens, 2017](#)). It is the nuclear DNA around which the whole concept of child's genetic identity and personality revolves as the former is the one to make a profound impact on the latter, not the mitochondrial DNA.

### 7.4. Germline intervention: a misconception

Critics of the technique are concerned about manipulation of the embryos considering it invalid morally which in actual, is a misconception. MRT is just like organ replacement *viz.* heart or kidney transplant or blood donation as culminated by the UK Department of health ([Dimond, 2015](#)). It involves the substantial replacement of defective mt-DNA with the healthy one without altering the sequence of genes inside it as in the case of genetic engineering ([Pompie and Pompie, 2018](#)) securing human asceticism.

## 8. Conclusion

Go to:

MRT is surely a breakthrough in the world of medical science. But due to shortsighted disadvantages and misinterpretation of the title, the technique is clutched into the strictly prohibited laws of the government in various countries mistaking it to be a sort of “Germline Modification”. MRT seems to be the only option for patients affected with mitochondrial impairment desiring to have a genetic child which is neither immoral nor illicit. The purpose of this review is not to demean other reproductive approaches but to put off the blindfold claiming that MRT disturbs the sacrosanctity of humanity or disrespects cultural and social values. If permitted under appropriate regulatory laws, strict clinical researches, and carefully monitored conditions, the substantial risks can be minimized ensuring safe results and high standards of reproductive medicine.

## עוֹבֵר מִשְׁלוֹשָׁה הוֹרִים - הַשְּׁפֵעַת הַד.נ.א. הַמִּיטוֹכּוֹנְדְרִי עַל יִיחּוֹס הָעוֹבֵר

### ז. סיכום

נחלקו הפוסקים, מי היא אמו של עובר שנולד מביצית שהוסיפו או החליפו לה את המעטפת שבה נמצאים המיטוכונדריונים.

לדעת הרב אשר וייס והרב דוד לאו, משקלו של גרעין התא, שבו נמצא רוב המטען הגנטי, מכריע בקביעת הייחוס. ולכן לדעת הרב אשר וייס אין מציאות של שתי אימהות לילד אחד. בעלת הגרעין היא האם היחידה.

מאידך, לדעת הרב שיינפלד והרב בקשי-דורון, לא ניתן למדוד שאלה זו בהלכות רוב ומיעוט, מאחר וייתכן כי לחלק המועט יש השפעה רבה יותר, ואולי אף יותר משמעותית על חיי היילוד. ואמנם הרב בקשי-דורון לא הכריע את הספק, ומחמת זאת פסק שאסור להוסיף ציטופלסמה של אשה אחת לביצית של אשה אחרת, וככל הנראה הוא גם יאסור להחליף את הציטופלסמה.

ברם למעשה עדיין יש מקום לדון אם כשיש ספק מי היא האם - שתיהן אמהות, או שאף אחת מהן אינה נחשבת האם. ומצאנו שנחלקו בזה הפוסקים לשיטת התוספות בשם הירושלמי, שאשה יכולה להתעבר משני אנשים.

לדעת הבית-יצחק, כרם-נטע, אגרות-משה, תשובות-והנהגות והרב זילברשטיין, כל מי שהוסיף חומר גנטי לעובר, נחשב כאב או כאם, ולכן תיתכן מציאות של שני אבות או שתי אימהות לאדם אחד.

ואילו לדעתו של הרב שפרן, כאשר אף אחת מהנשים לא נתנה את כל הביצית, אף אחת מהן אינה נחשבת האם.

*J. David Bleich*

## **SURVEY OF RECENT HALAKHIC PERIODICAL LITERATURE**

### **MITOCHONDRIAL DNA REPLACEMENT: HOW MANY MOTHERS?**

#### **VIII. CONCLUSION**

In summation, it can be stated that, apart from the serious concerns presented by crossing the germ line that may affect the very nature of future generations of human beings, the potential for harm to the prospective neonate as a result of mtDNA replacement represents an assumption of risk to a potential human being that, even if not formally interdicted, is antithetical to moral principles announced by the Sages of the Talmud. Moreover, formidable rabbinic opinion maintains that blurring of maternal identity and comingling of male sperm with genetic material of the wife of another man is as prohibited by Halakhah. *Post factum*, whether the birth mother is to be recognized as the sole halakhic mother or whether the child has multiple mothers remains a matter of significant dispute.<sup>46</sup>

# Two Gestational Mothers?

**A British Couple Just Became The First In The World To Carry The Same Baby**



# 2010 Lake Placid- Genetics

## May 27, 2010

The NEW ENGLAND JOURNAL of MEDICINE

REVIEW ARTICLE

### GENOMIC MEDICINE

W. Gregory Feero, M.D., Ph.D., and Alan E. Guttmacher, M.D., *Editors*

## Genomic Medicine — An Updated Primer

W. Gregory Feero, M.D., Ph.D., Alan E. Guttmacher, M.D.,  
and Francis S. Collins, M.D., Ph.D.

Cathy, a 40-year-old mother of three, arrives in your office for her annual physical. She has purchased a commercial genomewide scan (see the Glossary), which she believes measures the clinically meaningful risk that common diseases will develop, and has completed her family history online using My Family Health Portrait ([www.familyhistory.hhs.gov](http://www.familyhistory.hhs.gov)), a tool developed for this purpose by the U.S. Surgeon General. Her genomewide scan suggests a slightly elevated risk of breast cancer, but you correctly recognize that this information is of unproven value in routine clinical care. On importing Cathy's family-history file, your office's electronic health record system alerts you to the fact that Cathy is of Ashkenazi Jewish heritage and has several relatives with breast cancer, putting her at heightened risk for the hereditary breast and ovarian cancer syndrome. The system prompts you to discuss Cathy's risk of breast and ovarian cancer during the visit. Considering both her family history and ancestry, you refer Cathy to a health care professional with advanced genetics training for consultation.

# 2013 Lake Placid- Genetics



Dr. Ellen  
Warner

Jul 14,  
2013

Genetics, Judaism, and the 21st Century: 5th International Jewish Medical  
Ethics Conference 2013

# 2015 Bushkill

diseases.

## Angelina Jolie Pitt: Diary of a Surgery MARCH 24, 2015

TWO years ago I wrote about my choice to have a preventive double mastectomy. A simple blood test had revealed that I carried a mutation in the BRCA1 gene. It gave me an estimated 87 percent risk of breast cancer and a 50 percent risk of ovarian cancer. I lost my mother, grandmother and aunt to cancer. I wanted other women at risk to know about the options. I promised to follow up with any information that could be useful, including about my next preventive surgery, the removal of my ovaries and fallopian tubes.

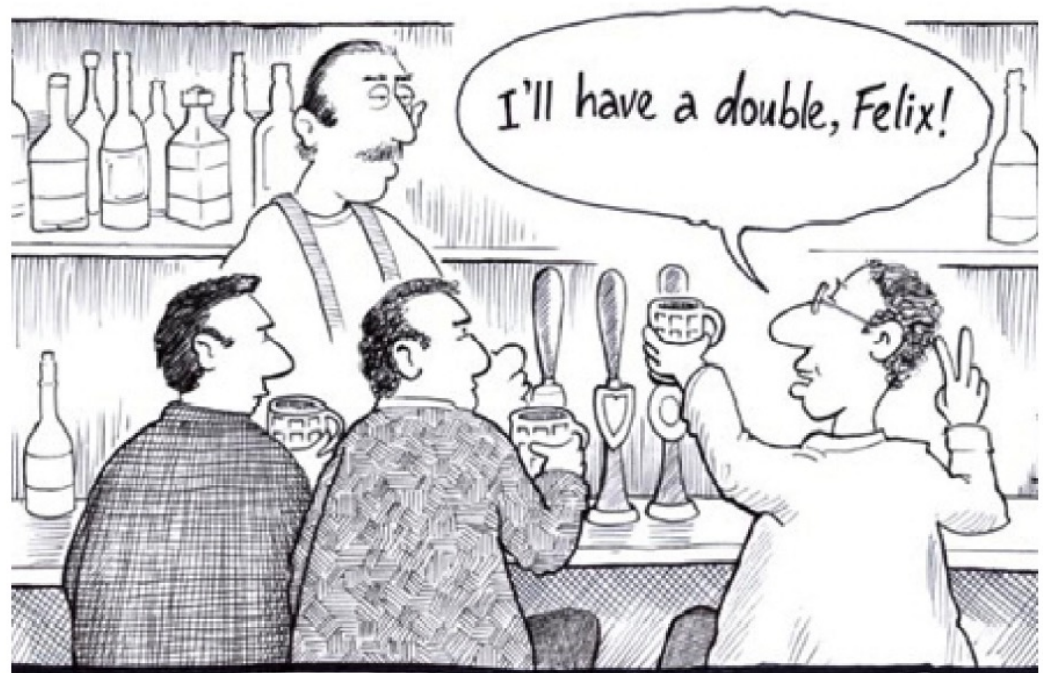

Cambridge, 1953. Shortly before discovering the structure of DNA, Watson and Crick, depressed by their lack of progress, visit the local pub.

## ***BRCA Testing for All Ashkenazi Women: A Halakhic Inquiry***

**By: SHARON GALPER GROSSMAN**

*I recently underwent testing for the BRCA mutation. Thank G-d, neither I nor anyone in my family has ever had breast or ovarian cancer. So, why would a woman who has never been diagnosed with cancer and has no family history of it undergo BRCA testing? This article presents the halakhic issues around offering BRCA testing to all Ashkenazi women regardless of family history, and introduces views of several modern poskim, who have not, until now, rendered an opinion on this topic.*



# 2015 Bushkill- CRISPR

## Engineering the Perfect Baby

**Scientists are developing ways to edit the DNA of tomorrow's children. Should they stop before it's too late?** March 5, 2015

The experiment ... would go like this: The researchers hoped to obtain the ovaries of a woman undergoing surgery for ovarian cancer, caused by a mutation in a gene called BRCA1. Working with another Harvard laboratory they would extract immature egg cells that could be coaxed to grow and divide in the laboratory. Yang would use CRISPR in these cells to correct the DNA of the BRCA1 gene. The objective is to create a viable egg without the genetic error that caused the woman's cancer.

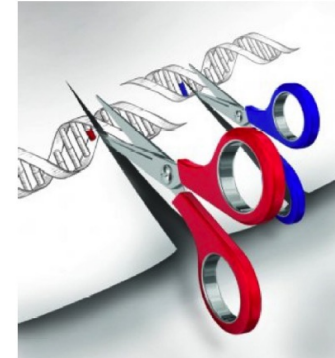

## Scientists Seek Ban on Method of Editing the Human Genome MARCH 19, 2015 NYT

A group of leading biologists on Thursday called for a worldwide moratorium on use of a new genome-editing technique that would alter human DNA in a way that can be inherited. The biologists fear that the new technique is so effective and easy to use that some physicians may push ahead before its safety can be assessed. They also want the public to understand the ethical issues surrounding the technique, which could be used to cure genetic diseases, but also to enhance qualities like beauty or intelligence.

# 2017 Montreal- CRISPR



Rabbi Dr. Avraham  
Steinberg

Jul 27,  
2017

Slicing & Dicing Genes: CRISPR Technology in Halacha

# 2019 Saratoga Springs CRISPR

## Gene Edited Babies Born in China November 26, 2018

Hong Kong (CNN) Ñ The Chinese government has ordered an "immediate investigation" into the alleged delivery of the world's first genetically edited babies, as experts worldwide voiced outrage at such use of the technology. The pushback comes amid claims made online by Chinese scientist He Jiankui that twin girls had been born with DNA altered to make them resistant to HIV, a groundbreaking move that is likely to spark significant ethical questions around gene editing and so-called designer babies.



*"What kind of god are you playing? The New Testament God,  
or the Old Testament God?"*

© Rina Piccolo.

# China jails 'gene-edited babies' scientist for three years

🕒 30 December 2019



He Jiankui sparked an international backlash with his experiment last year

**A scientist in China who said he had created the world's first gene-edited babies has been jailed for three years.**

He Jiankui was convicted of violating a government ban by carrying out his own experiments on human embryos, to try to give them protection against HIV.

# Press release: The Nobel Prize in Chemistry 2020

English

[English \(pdf\)](#)

Swedish

[Swedish \(pdf\)](#)



7 October 2020

The [Royal Swedish Academy of Sciences](#) has decided to award the Nobel Prize in Chemistry 2020 to

**Emmanuelle Charpentier**

Max Planck Unit for the Science of Pathogens, Berlin, Germany

**Jennifer A. Doudna**

University of California, Berkeley, USA

*“for the development of a method for genome editing”*

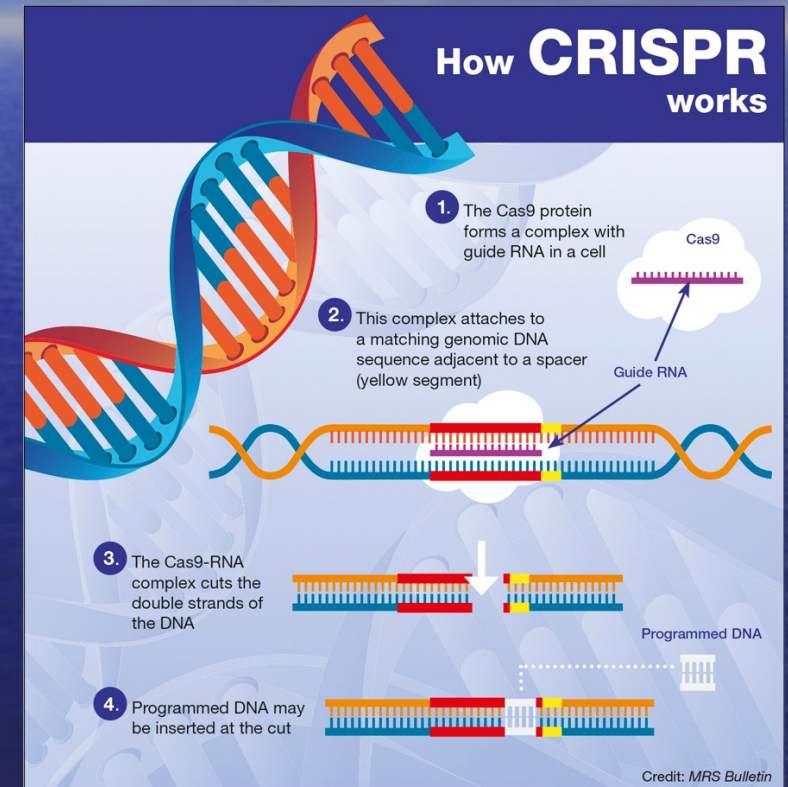

## New Israeli tech gives accuracy boost to microscopic scissors for DNA editing

The CRISPR technique snips DNA, but what if it cuts the wrong location in the genome without scientists realizing?  
Software innovation provides alerts

By NATHAN JEFFAY

24 May 2021, 2:20 pm

Israeli scientists have developed a “quality assurance” method for genome editing, which they say has the power to make it easier to translate DNA technologies from theory to treatments.

The CRISPR genome editing system works by cutting DNA with microscopic “scissors” and fixing it. The method is deployed to address some genetic disorders, and there are huge efforts to expand its use.

But one of the teething troubles is accuracy. “Like every house has an address you use to find it, every gene has an ‘address’ that we use to target CRISPR editing, but sometimes there is a lack of accuracy and the tiny ‘scissors’ go to the wrong place,” said molecular biologist Dr. Ayal Hendel of Bar Ilan University.

He has pioneered a new method for assessing, with an unprecedented level of accuracy, how many mistakes creep in when a genome editing tool is used, and where the mistakes occur. An academic paper on the breakthrough is due to appear on Monday in the peer-reviewed journal Nature Communications.

# 2019- Saratoga Springs Ancestry DNA Testing

## **Population Genetics**

### **Israeli Scientists Say Public Genealogy Databases Can Be Used to Identify Everybody**

By JNi.Media - 5 Heshvan 5779 - October 13, 2018

Yaniv Erlich, Tal Shor, Itsik Pe'er, and Shai Carmi, who are affiliated with online genealogy platform MyHeritage, as well as Columbia University, The Hebrew University of Jerusalem, and the New York Genome Center, last Thursday published a report in Science Magazine ([Identity inference of genomic data using long-range familial searches](#)) suggesting that as DNA databases continue to grow, investigators will be able to identify anyone in the US given a sample of their DNA. Consumer genomics databases have

reached the scale of millions of individuals, say the authors of the report, noting that recently, law enforcement authorities have exploited some of these databases to identify suspects via distant familial relatives. "Using genomic data of 1.28 million individuals tested with consumer genomics, we investigated the power of this technique. We project that about 60% of the searches for individuals of European-descent will result in a third cousin or closer match, which can allow their identification using demographic identifiers," the report states.

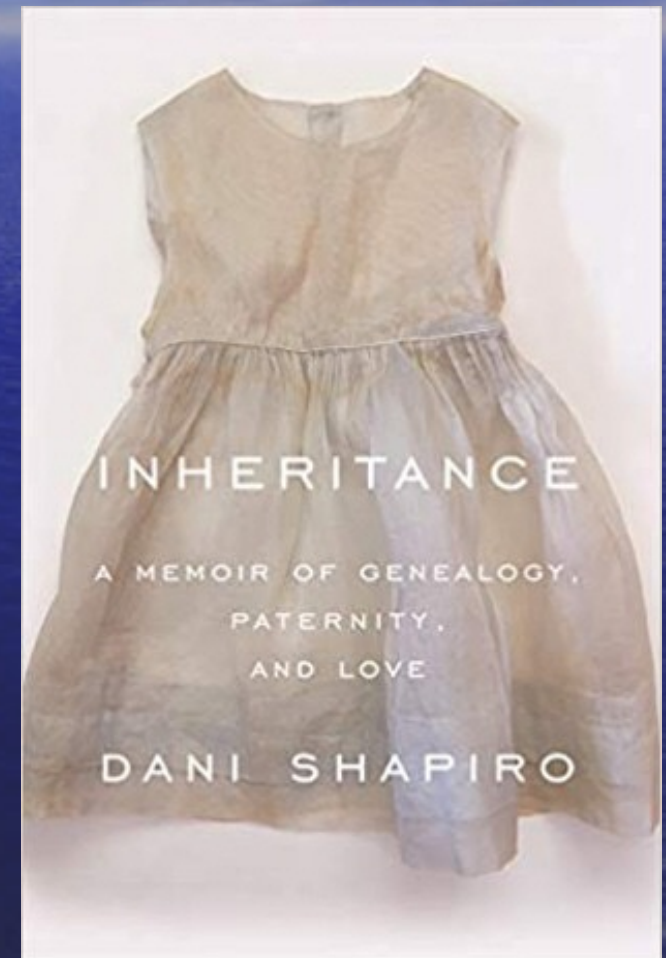
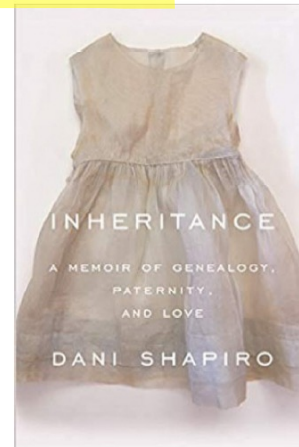



Joseph DeAngelo, the suspected Golden State Killer RANDY PENCH/TNS/NEWSCOM

## We will find you: DNA search used to nab Golden State Killer can home in on about 60% of white Americans

By [Jacelyn Kaiser](#) | Oct. 11, 2018, 2:00 PM

## Sperm Donors Can't Stay Secret Anymore. Here's What That Means.

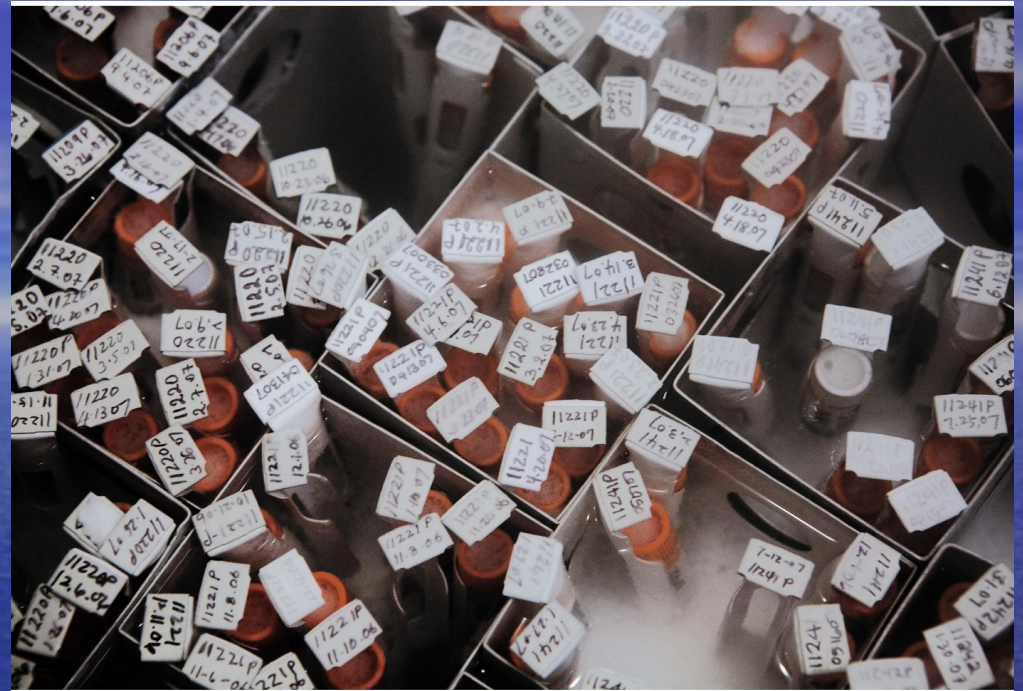

Vials of donor sperm frozen by liquid nitrogen in a holding tank at the California Cryobank. Ted Soqui/Corbis via Getty Images

To be the biological child of an anonymous sperm donor today is to live in a state of perpetual anticipation. Having never imagined a world in which donors could be tracked down by DNA, in their early years sperm banks did not limit the number of families to whom one donor's sperm would be sold — means that many of the children conceived have half-siblings in the dozens. There are hundreds of biological half-sibling groups that number more than 20, according to the [Donor Sibling Registry](#), where siblings can find one another, using their donor number. Groups larger than 100, the registry reports, are far from rare.

Because of the increasing popularity of genetic testing sites like 23andMe, in the past two or three years a whole new category of people, including those who never knew they were conceived via donor insemination, are reaching out to half siblings who may have already connected with others in their extended biological family. These individuals have no idea when the number of their donor siblings will reach its final limit, or on which day an email will arrive from yet another family member of sorts, someone who is looking for connection or nothing in particular or has an eerily similar birthmark in the same place on a cheek.



**I'm 20. I Have 32 Half Siblings. This Is My Family Portrait.**

I always knew I was conceived using a sperm donor. But I never really understood what that meant until I went searching for my brothers and sisters.



# I fathered 800 children, claims sperm donor

By Natalie Morton & Sarah Bell  
Victoria Derbyshire programme

🕒 13 January 2016

Feb. 1, 2021

## *The Case of the Serial Sperm Donor*

One man, hundreds of children and a burning question: Why?

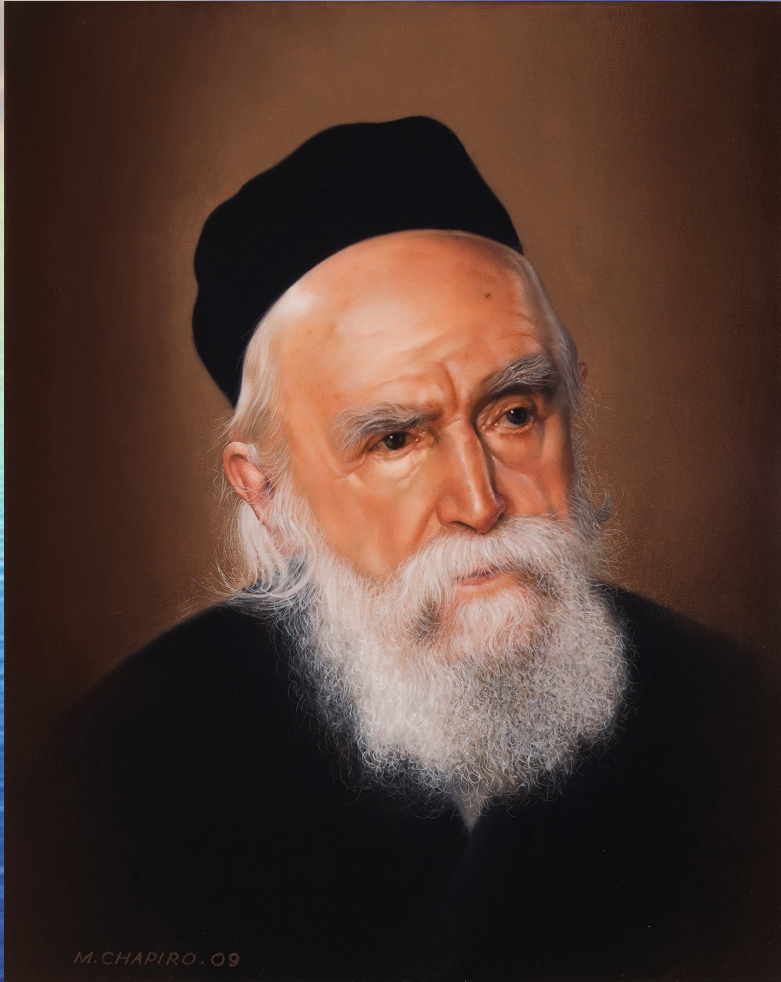

Rav Moshe Feinstein, zt"l

אבל מכיון שהטעם מפורש שם שהוא מדין  
גזירה שמא ישא אחותו מאביו וכן הוא בב"ש  
סימן א' סק"י, יש להתיר בזרע של נכרי שכיון  
שהולד יהיה ישראל כיון שאמו ישראלית אין  
לחוש לכלום דאין לו יחוס להאב הנכרי אף אם  
היה דרך ביאה וכ"ש כשאינו דרך ביאה אלא  
מאמבטי... ולכן יש להתיר בשעת הדחק גדול  
ומצטערים מאד בהשתוקקם לולד, לזרוק להאשה  
במעיה זרע של נכרי דוקא. ומסתבר שאף סתם  
זרע יש לתלות שהוא של נכרים כי רוב אלו  
שמוציאין זרעם לזה הם נכרים...

The major concern with artificial insemination is the possibility of marrying a paternal sibling (consanguinity). As such, it would be permitted to use the seed of a non-Jew, as in this case, paternity is not conferred upon the man (even in the case of a physical relationship). Since there is no legal father, there is no possibility of marrying a paternal sibling (as none exists).



**F**ive years ago, Alice Collins Plebuch made a decision that would alter her future — or really, her past.

**WHO WAS SHE? A DNA TEST  
ONLY OPENED NEW  
MYSTERIES.**

How Alice Collins Plebuch's foray into "recreational genomics" upende

She sent away for a “just-for-fun DNA test.” When the tube arrived, she spit and spit until she filled it up to the line, and then sent it off in the mail. She wanted to know what she was made of.

Plebuch, now 69, already had a rough idea of what she would find. Her parents, both deceased, were Irish American Catholics who raised her and her six siblings with church Sundays and ethnic pride. But Plebuch, who had a long-standing interest in science and DNA, wanted to know more about her dad’s side of the family. The son of Irish immigrants, Jim Collins had been raised in an orphanage from a young age, and his extended family tree was murky.

After a few weeks during which her saliva was analyzed, she got an email in the summer of 2012 with a link to her results. The report was confounding.

About half of Plebuch’s DNA results presented the mixed British Isles bloodline she expected. The other half picked up an unexpected combination of European Jewish, Middle Eastern and Eastern European. Surely someone in the lab had messed up. It was the early days of direct-to-consumer DNA testing, and Ancestry.com’s test was new. She wrote the company a nasty letter informing them they’d made a mistake.

# Ancestry DNA Testing

## What will you find?

### **A 'SWAB OF SPIT' REUNITES EXTENDED FAMILY AFTER A CENTURY**

The Pincus family had been separated through time and space, but thanks to DNA testing, they have finally found each other.

BY ILANIT CHERNICK JULY 21, 2019

For almost a century, two sides of the Pincus family had been separated by time and space. Each side suspected that there were family members living in some far-off place but could never be sure of who they were or how to find them. Recently, however, two members of the family living in the United States separately took DNA tests, which finally answered the burning questions regarding the long-lost other side of the Pincus family's whereabouts.



## 75 Years After 2-Year-Old and Mother Separated at Auschwitz, Their Families Find Each Other

By Esther · June 7, 2020 · User Stories

Like 3.8K

Comments

Share

Tweet

Email

Share

When Clare Reay's son bought her a [MyHeritage DNA test](#), she hoped to discover a little about her mother's ethnic background.

She never imagined that the test would lead her to solve the mystery of her mother's origins and find the sisters who had been searching for her for more than 50 years.

# 2012 Connecticut 1<sup>st</sup> Trachea Transplant



**Cancer patient receives stem cell-made windpipe, first in U.S.** January 16, 2012

(CBS) In only the second operation of its kind, a Baltimore man has received an artificial windpipe made from stem cells to replace one destroyed by cancer. Christopher Lyles, 30, had tracheal cancer that had progressed so far it was considered inoperable, the New York Times reported. In November, doctors made him a new windpipe - or trachea - made out of tiny plastic fibers seeded with stem cells from his own bone marrow. Two months after his successful operation, Lyles arrived home in Md. last week.

Surgeon Paolo Macchiarini, a professor of regenerative surgery at Karolinska Institute in Stockholm, performed the surgery. He's also the doctor who performed the first surgery of this kind on a 31-year-old Eritrean man last July.



MEDICINE NEWS

## Paolo Macchiarini indicted for aggravated assault in Sweden

Swedish prosecutor opened a criminal indictment against Paolo Macchiarini. The scandal surgeon will have to stand court trial for all 3 deadly plastic trachea transplants he performed at Karolinska.

### Disgraced tracheal transplant surgeon is handed 16 month prison sentence in Italy

*BMJ* 2019 ; 367 doi: <https://doi.org/10.1136/bmj.l6676> (Published 25 November 2019)

Cite this as: *BMJ* 2019;367:l6676

Article

Related content

Metrics

Responses

Michael Day

Author affiliations ▼

Disgraced surgeon Paolo Macchiarini, who faked research relating to dangerous and largely discredited tracheal transplants, has been handed a 16 month prison sentence in Italy for forging documents and abuse of office.

Macchiarini made headlines around the world after claiming a major breakthrough for patients with failing windpipes, by “seeding” an artificial scaffold with a patient’s own stem cells, to generate a functioning trachea.

But excitement at the prospect of a genuine medical advance turned to scandal when it emerged that Macchiarini had falsified results and misled hospital authorities regarding the health of those receiving the experimental procedures. The revelation prompted his research centre, the Karolinska Institute, to eventually disown his ...



# Mount Sinai Surgeons Perform First Human Tracheal Transplant Surgery

*Historic case launches Mount Sinai's Tracheal Transplant Program for treating patients worldwide, including those with severe intubation damage after COVID-19*



[Mount Sinai Surgeons Perform First Human Tracheal Transplant Surgery](#)

**New York, NY (April 06, 2021)** – A team of Mount Sinai surgeons has performed the world's first human tracheal transplant—an achievement that has the potential to save the lives of thousands of patients around the world who have tracheal birth defects, untreatable airway diseases, burns, tumors, or severe tracheal damage from intubation, including those who had been hospitalized with COVID-19 and placed on a ventilator. Until now, no long-term treatments existed for these patients with long-segment tracheal damage, and thousands of adults and children died each year as a result.

# 2012 Connecticut- Uterus Transplant

## **World's First Turkish Womb Transplant Is A Success**

**October 5, 2011**

Derya Sert is the 21 year old who had the world's first successful womb transplant at a Turkish hospital. On August 9th, 2011, doctors at Akdeniz University Hospital in Turkey, successfully transplanted a uterus to Derya Sert, who was born without a uterus, without any major complications.

## **Embryo to be transferred to world's first uterine recipient**

**July 27, 2012**

Another international medical success could be in the making as doctors at Akdeniz University Hospital prepare for an embryo implant in September for Derya Sert, who was the first woman in history to have received a womb from a deceased donor, and is the world's first successful uterus transplant patient.

The transplant recipient has had 11 menstrual periods since the transplant operation, and it is reported by the university that the transplanted uterus is fully functioning.



# 2015 Bushkill

First BIRTH from a uterus transplant

## Swedish woman world's first to give birth after womb transplant

STOCKHOLM Sat Oct 4, 2014 (Reuters) - A Swedish woman has become the world's first to give birth after having a womb transplant, opening up the possibility for thousands of infertile women to have babies, the doctor in

charge of the research project said on Saturday. She was one of seven women who successfully underwent a womb transplant from a live donor – in most cases the recipient's mother - and subsequently had in vitro fertilization (IVF) treatment.



Bonyhád 15 Cheschw 5668 **WAJLAKET JOSZEF** Zehnter Jahrgang No 3  
Halbmonatliche Zeitschrift - Organ für bairisch und agerische Abhandlungen  
Pränumerationspreis: Ganzjahrg für Osterreich-Ungaru 6 Kronen (Halbjährig 3 Kronen)  
für Deutschland 7 Kronen - für das weitere Ausland 8 Kronen.

### וילקט יוסף

בשנת ה'תרע"ד קצ"ח על ידי מלכודים בשמות חיים ומחוקקת היתה מקרה נפלא ונחמד ונחמד לנחמד  
הנפלא אשר יחידו הויה בעצם חכם ופועל וזמן נחמד ונחמד ונחמד ונחמד ונחמד ונחמד ונחמד  
הן שוק לנחמד קצת שנים ולחיים קצת חכם ונחמד ונחמד ונחמד ונחמד ונחמד ונחמד ונחמד  
לחיים שוק חכם ולחיים ונחמד ונחמד ונחמד ונחמד ונחמד ונחמד ונחמד ונחמד ונחמד ונחמד

Pränumerationspreis	Halbmonatliche Zeitschrift	5 Kronen
Pränumerationspreis	Ganzjahrg für Osterreich-Ungaru	6 Kronen
Pränumerationspreis	Halbjährig	3 Kronen
Pränumerationspreis	für Deutschland	7 Kronen
Pränumerationspreis	für das weitere Ausland	8 Kronen

# Uterus Transplant

UFI is estimated to affect as many as 5% of childbearing-aged women worldwide and once was an irreversible form of female infertility. The first successful uterus transplant was performed in Sweden in 2014. As of late 2020, roughly 100 uterus transplants have been performed in the world, including about 30 in the United States.

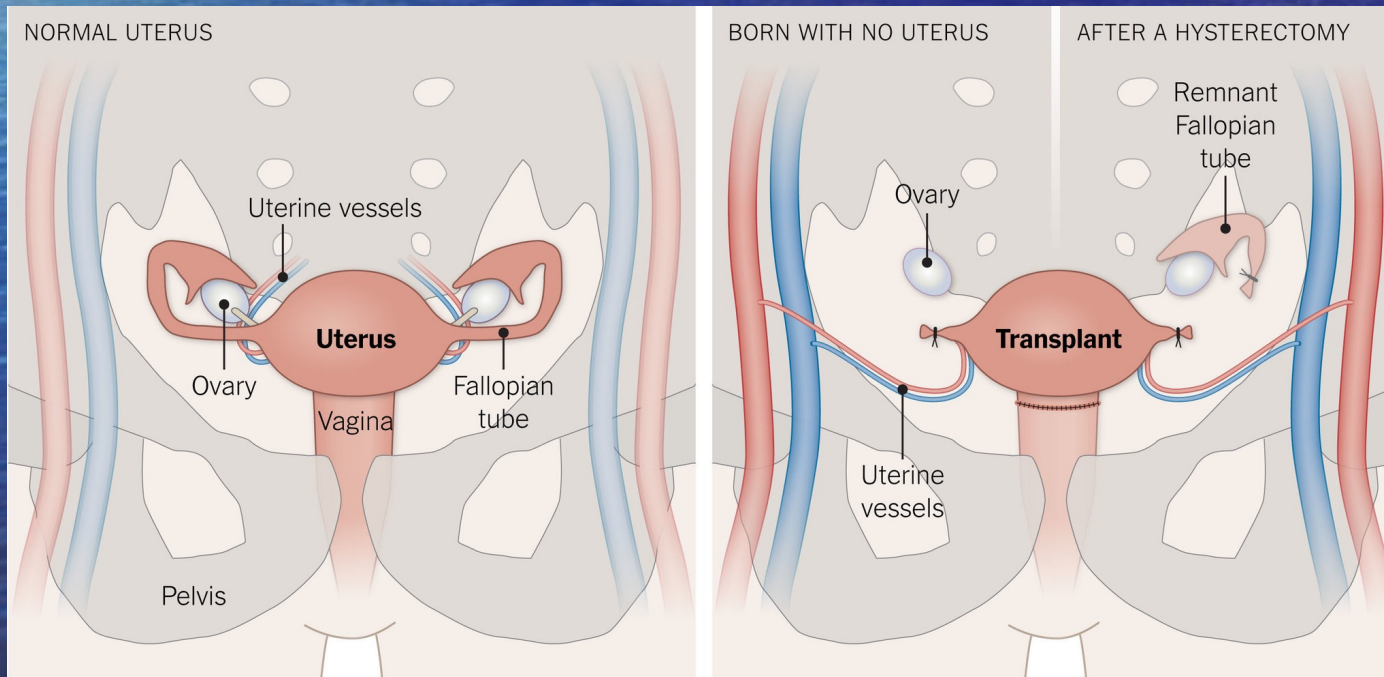

# 2012 Connecticut- Male Pregnancy

## The Future of Reproduction: Male Pregnancy

by Aaron Rowe April 27, 2009

Male pregnancy? It sounds like the setup for *Junior*, the 1994 comedy starring Arnold Schwarzenegger as a scientist who impregnates himself. .. Anthony Atala, a researcher at Wake Forest University, has already grown several bladders in his lab and implanted them in children who were born with urinary defects. Structurally speaking, a womb and a bladder are quite similar organs. A womb transplant, on the other hand, has already been tried—once. It wasn't successful, but Edwin Ramirez, a reproductive surgeon in California, is actively developing a procedure to transplant a healthy uterus from one woman to another. He thinks that it would be possible to give men a uterus transplant too.





Original Investigation | Obstetrics and Gynecology

## Perceptions and Motivations for Uterus Transplant in Transgender Women

Benjamin P. Jones, BSc (Hons); Abirami Rajamanoharan, BSc (Hons); Saaliha Vali, BSc (Hons); Nicola J. Williams, PhD; Srdjan Saso, PhD; Meen-Yau Thum, MD; Sadaf Ghaem-Maghami, PhD; Isabel Quiroga, DPhil; Cesar Diaz-Garcia, PhD; Philip Thomas; Stephen Wilkinson, PhD; Joseph Yazbek, MD; J. Richard Smith, MD

### Abstract

**IMPORTANCE** Uterus transplant has been demonstrated to be a viable fertility-restoring treatment for women categorized as female at birth with absolute uterine factor infertility. Recent advancements, as well as considerations of fairness and equality in reproductive care, have now led to the possibility of uterus transplant being undertaken in transgender women.

### Key Points

**Question** What are the perceptions and motivations of transgender women for uterus transplant?

**Findings** This survey study of 182



**BJOG** An International Journal of Obstetrics and Gynaecology

The reproductive aspirations of M2F transgender women deserve equal consideration to those assigned female at birth and, subject to feasibility being shown in the suggested areas of research, it may be legally and ethically impermissible not to consider performing UTx in this population.

DOI: 10.1111/1471-0528.15438  
www.bjog.org

## Uterine transplantation in transgender women

BP Jones,<sup>a,b</sup> NJ Williams,<sup>c</sup> S Saso,<sup>a,b</sup> M-Y Thum,<sup>b,d</sup> I Quiroga,<sup>e</sup> J Yazbek,<sup>a,b</sup> S Wilkinson,<sup>c</sup> S Ghaem-Maghami,<sup>a,b</sup> P Thomas,<sup>f</sup> JR Smith<sup>a,b</sup>

<sup>a</sup> West London Gynaecological Cancer Centre, Hammersmith Hospital, Imperial College NHS Trust, London, UK <sup>b</sup> Department of Surgery and Cancer, Imperial College London, London, UK <sup>c</sup> Department of Politics, Philosophy and Religion, Lancaster University, Lancaster, UK

<sup>d</sup> Lister Fertility Clinic, The Lister Hospital, London, UK <sup>e</sup> The Oxford Transplant Centre, The Churchill Hospital, Oxford University Hospitals NHS Trust, Oxford, UK <sup>f</sup> Brighton Gender Clinic, Nuffield Health Hospital, Brighton, UK

*Correspondence:* Mr BP Jones, Department of Surgery and Cancer, Imperial College London, Du Cane Road, London W12 0NN, UK.  
Email: Benjamin.jones@nhs.net

April 27, 2021

PROFILES IN SCIENCE

# *Reinventing the Uterus, One Organoid at a Time*

Bioengineer Linda Griffith once grew a human ear on the back of a mouse. Now she is reframing endometriosis — a “women’s disease” — as a key to unlocking some of biology’s greatest secrets.



# Human Brain Surrogates Research: The Onrushing Ethical Dilemma

Henry T. Greely

To cite this article: Henry T. Greely (2021) Human Brain Surrogates Research: The Onrushing Ethical Dilemma, *The American Journal of Bioethics*, 21:1, 34-45, DOI: [10.1080/15265161.2020.1845853](https://doi.org/10.1080/15265161.2020.1845853)



# 2010 Lake Placid- Face Transplants

## Non-Vital Organ Transplants

**Nation's first face transplant done in  
Cleveland AP 12/16/08**

The nation's first near-total face transplant has been done on a woman at the Cleveland Clinic, the hospital announced Tuesday. Reconstructive surgeon Dr. Maria Siemionow replaced nearly all of the woman's face — 80 percent — with that of a dead female donor in an operation a couple weeks ago. The patient's name and age were not released. The hospital plans a news conference Wednesday and would not give details until then



"Why the long face?"

> [Plast Reconstr Surg.](#) 2021 Jun 1;147(6):1022e-1038e. doi: 10.1097/PRS.00000000000007932.

# Facial Transplantation: Principles and Evolving Concepts

Rami S Kantar<sup>1</sup>, Allyson R Alfonso<sup>1</sup>, Gustave K Diep<sup>1</sup>, Zoe P Berman<sup>1</sup>, William J Rifkin<sup>1</sup>,  
J Rodrigo Diaz-Siso<sup>1</sup>, Michael Sosin<sup>1</sup>, Bruce E Gelb<sup>1</sup>, Daniel J Ceradini<sup>1</sup>,  
Eduardo D Rodriguez<sup>1</sup>

**Summary:** This CME article highlights principles and evolving concepts in facial transplantation. The field has witnessed significant advances over the past two decades, with more than 40 face transplants reported to date. The procedure now occupies the highest rung on the reconstructive

**World's first face and hands transplant gives  
New Jersey man a second chance at life**  
By Evan Simko-Bednarski, CNN Wed February 3, 2021



# 2015 Bushkill Pfizer

## **Pfizer Prescription Medication for Gaucher Disease Receives OU Kosher Certification** May 14, 2014

Pfizer Inc. today announced that the Orthodox Union (OU) has granted kosher certification to ELELYSO<sup>a</sup> (*taliglucerase alfa*) for injection, an enzyme replacement therapy (ERT) for the long-term treatment of adults with a confirmed diagnosis of Type 1 Gaucher disease. ELELYSO is the first prescription medication to be certified kosher by the OU.



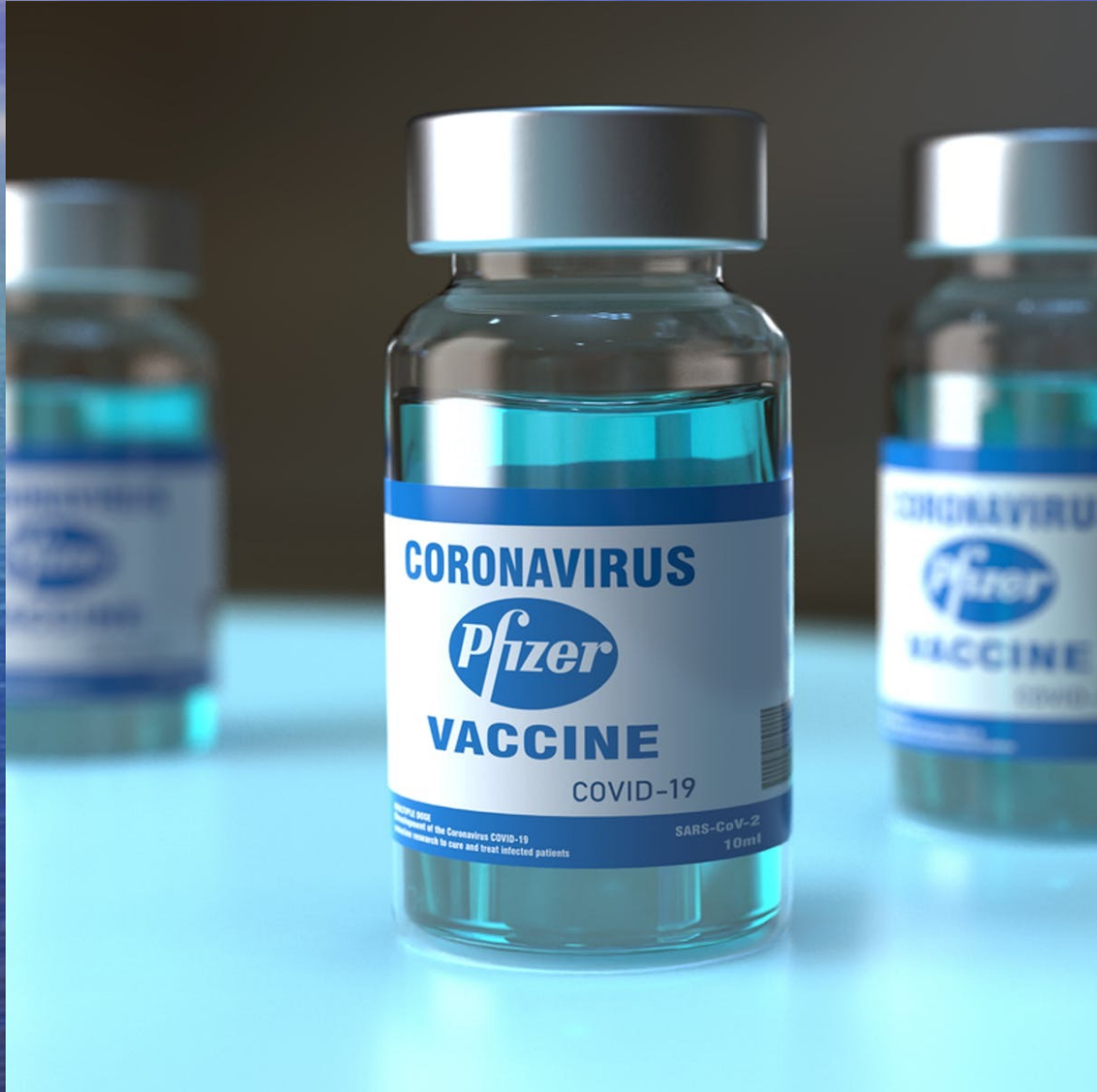

# 2019 Saratoga Springs Vaccinations

## **Vaccination**

### **Israeli Health Ministry Weighing Criminal Sanctions Against Samaria Vaccine Refusers** By JNi.Media - 15 Sivan 5778 – May 29, 2018

The Israeli Ministry of Health has warned residents of the community of Itamar in Samaria to get immunized against the measles, or the government would be forced to apply the exceptional clause-Article 19- of the Public Health Ordinance, which permits it to fine and even imprison anyone who refuses to be vaccinated in an area where there has been an outbreak of a contagious disease.

### **Politician pushes for vaccinations after Jerusalem baby dies from measles**

By SARAH LEVI 11/01/2018

The total number of measles cases nationwide stands at 1,287, a majority of which are in Jerusalem with 753 residents infected.

Following the death of [an 18monthold baby from the measles in Jerusalem](#) on Thursday, another push to require vaccinations from the disease is hitting the Knesset.

Her parents were members of Neturei Karta, an extreme stream of ultraOrthodox Judaism in the haredi neighborhood of Mea She'arim. The baby was reportedly not vaccinated from the disease nor was she brought to the doctor for checkups until she was taken to the hospital without a pulse on Thursday.

# 2019 Saratoga Springs Anti-vaxxers

NYT April 9, 2019

"Vaccines contain monkey, rat and pig DNA as well as cow-serum blood, all of which are forbidden for consumption according to kosher dietary law," Moishe Kahan, a contributing editor for Peach magazine, said in an email.

## ***'Monkey, Rat and Pig DNA': How Misinformation Is Driving the Measles Outbreak Among Ultra-Orthodox Jews***

Handbooks distributed in some Jewish communities in New York, as well as messages on hotlines, contradict the scientific consensus that vaccines are safe and highly effective.

# Are Vaccines Kosher?

LATESTLY | Latestly

## COVID-19 Vaccines Containing Pork Gelatin Permissible for Muslims, Says UAE Fatwa Council



Team Latestly

23 December 2020 · 2-min read

SAVE UP TO 75%

### ‘No evidence’ COVID-19 contains pork, causes infertility - Jewish doctors

An open letter signed by more than 70 medical doctors sought to quash conspiracy theories circulating that the vaccine contains products that are non-kosher.

By GADI ZAIG JANUARY 2, 2021 15:00



Jewish doctors warned against [conspiracy theories claiming](#) the COVID-19 vaccine causes infertility or contains products derived from pork.

[Jewish News](#) reported on Friday that the open letter, signed by more than 70 British-Jewish doctors and published on Tuesday, warns against falling for such conspiracy theories and states there is “absolutely no evidence” the [Pfizer vaccine](#) contains any non-kosher ingredients.



# Swine Flu



האם קיים איסור על אכילת בשר חזיר? במשרד הבריאות מבהירים כי אין כל חשש מאכילת מזונות וכי המחלה איננה מועברת במזון בארגון הבריאות העולמי מדגישים כי אין חשש מאכילת בשר חזיר שבושל כהלכה

Is there a prohibition to eat pork (re. catching Swine Flu)? No! The Ministry of Health clarifies that there is no danger in food consumption. The disease is not transmitted through food. The WHO emphasizes that there is nothing to be concerned about eating pork that is cooked "according to Halacha"

# Vaccines and Fetal Cell Lines: Is it Kosher?

**Bishops urge Catholics to avoid the Johnson & Johnson vaccine if possible because it was developed using cells from an aborted fetus**

Julie Gerstein Mar 3, 2021, 2:15 AM



When testing whether their vaccines work, both Pfizer and Moderna used fetal cell lines derived from fetal tissue taken from elective abortions in the 1970s and 1980s, according to James Lawler, an infectious-disease specialist at Nebraska Medicine. They did not use the lines during the development or production phases, so they are not inside the injection, Lawler said. In creating its vaccine, Johnson & Johnson used cells that are descended from tissue taken from a 1985 elective abortion.

ויסוד השאלה מצד

איסור הנאה מן המת.

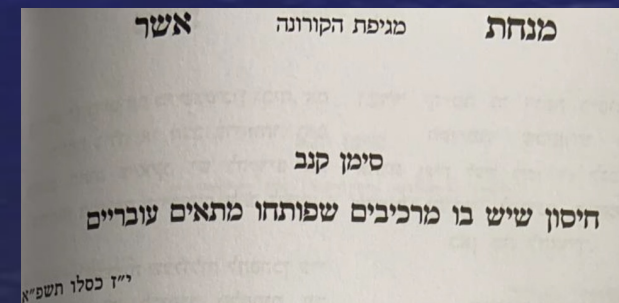

והנושא שלגביו נחלקו שני גדולי  
עולם הרדב"ז והגנת ורדים,  
במה שנהגו לרפא את החולים מבשר  
מומיות (מתים חנוטים) ודנו הגאונים דהא  
תינח בחולה שיש בו סכנה אבל בחולה  
שאינ בו סכנה מה היתר יש בדבר. והגנת  
ורדים אכן כתב לאסור, אך הרדב"ז כתב  
להקל מכמה טעמים:

ביון שמשתמשים בכמה מיני סמים על  
מנת למנוע רקבון של בשר המת,  
הוי כנשתנה לגמרי וכמו מוסק ותריאקי  
ופנים חדשות באו לכאן. אך טעם זה  
לשיטתו לא מהני אלא באיסורי אכילה  
אבל לא באיסורי הנאה, דלא גרע  
מאיסורי הנאה הנקברין שאפרן אסור.

ולגבי איסור הנאה כתב דכיון דהוי שלא  
כדרך הנאתו מותר. אך עדיין  
נתקשה מה היתר יש לסחור במומיות  
ולהרויח ממכירתן. ומשור"כ פסק למעשה  
דמת עכו"ם מותר בהנאה, וכדברי התוס'  
בב"ק (שם).

ושאלה זו אם מת נכרי אסור בהנאה  
שנויה במחלוקת גדולה,  
ואבאר בקצרה.

הבית יוסף בבדק הבית (יו"ד סימן שמ"ט)  
הביא מתשובת הרשב"א (ח"א  
סימן שס"ה) שמת אסור בהנאה, לא שנא  
ישראל ונכרי, וכך פסק בשו"ע (שם ס"א).

א. הנה מבוואר בגמ' שמת אסור בהנאה  
ולמדו גז"ש מעגלה ערופה שאסורה  
בהנאה. עיין סנהדרין (מ"ז ע"ב) ועבו"ז  
(כ"ט ע"ב).

אך י"א שאין האיסור אלא מדרבנן, כן  
כתב בשאילת יעבץ (ח"א סימן ע"א)  
ובמשנה למלך (פי"ד מהל' אבל הכ"א)  
שנסתפק בזה בדעת הרמב"ם, עי"ש.

ונחלקו אם יש איסור אף שלא כדרך  
הנאה, בשו"ת גנת ורדים (יו"ד  
כלל א' סימן ד') נקט דאסור אפילו שלא  
כדרך הנאתו, והביאו הגרעק"א (יו"ד סימן  
שמ"ט), אך בשו"ת הרדב"ז (ח"ג סימן  
תקמ"ח) כתב דאין איסור הנאה ממת שלא  
כדרך הנאתו.

# Mumia and Mummies

(16<sup>th</sup> century)

שו"ת רדב"ז חלק ג סימן תקמח

(תתקעט) שאלת ממני אודיעך דעתי על מה שמכרו העולם להתרפאות בבשר המת הנקרא מומ"א ושלא במקום סכנה ובדרך הנאתו ולא עוד אלא שמסתחרין בו ונושאים ונותנים בו והוא מאיסורי הנאה דק"ל"ן דבשר המת אסור בהנאה דכתיב ותמת שם מורים:

תשובה איסור אכילה לא הוצרכת לשאול דודאי מותר באכילה שהרי נשתנה צורתו וחזר להיות עפר בעלמא וכ"ש ע"י סמים שהרי המומי"א היא בשר החנוטין שחונטין אותם בכמה מיני סמים כדי להעמיד צורתו וגופו וחזר להיות כעין זפת ואין בו איסור אכילה.....

RABBI DAVID BEN ZIMRA (Chief Rabbi of Egypt)

Is it permissible to use the flesh of a corpse, called mumia, for medicinal purposes? Furthermore, can one trade in this mumia, or does this run counter to the Biblical prohibition of deriving benefit from a corpse?



"Okay, folks, that's a wrap!"

# Vaccine Hesitancy Is as Old as Vaccines. I Take Comfort in That.

April 28, 2021



*The Cow Pock — or — the Wonderful Effects of the New Inoculation! — vide the Publications of the Anti-Vaccination Society*

An 1802 engraving shows a doctor, possibly Edward Jenner, with a “victim” of his vaccine. They are surrounded by the already vaccinated, who exhibit some worrying cow-related side effects. James Gillray, via Historica Graphica Collection/Heritage Images, via Getty Images

**By David Motadel**

Mr. Motadel is a historian at the London School of Economics and Political Science.

# Compulsory Vaccination London late 1800's



Illustration from a publication of the London Society for the Abolition of Compulsory Vaccination, mid-1880s. From the illustration's caption:  
Source: The Historical Medical Library of The College of Physicians of Philadelphia, via [HistoryOfVaccines.org](http://HistoryOfVaccines.org)

# Jewish Vaccine Caution/Hesitancy Covid Vaccine

**בית הוראה לעניני רפואה**  
מענה ויעוץ הלכתי רפואי

בס"ד, כסלו תשפ"א

## אודות היסוני קורונה

במענה לשאלת רבים אודות החיסונים החדשים נגד נגיף הקורונה, לאחר העיון בנושא ושמיעת חוות דעתם של רופאים מומחים.

הנגו להביע בואת את דעתנו, כי כל עוד שלא הוברר בוודאות התועלת שיש בהם, וכל זמן שלא נשללו לחלוטין הנזקים שעלולים להופיע בגינם, אין בידינו להמליץ על השימוש בהם, ובשלב זה ראוי לנהוג בשבט ואל תעשה. [לכשיבוררו הדברים לאשורם, נידון בזה מחדש].

וע"ז באנו על התתום

נאם: יחיאל מיכל פרידמן	נאם: יוסף מרדכי שלמון	נאם: שלמה יצחק שטרן
נאם: אהרן רייזר	נאם: אברהם פנחס קורין	נאם: שמעון נבנאל

כן הוא הדרך הישרה והנכונה לענ"ד

*[Signature]*

רחוב רבי עקיבא 46 בני ברק 5127302 טלפון: 03-6161616 שלוחה 3 | פקס: 0722-606361

## Covid-19 Vaccine INFORMATION

### Should I really be taking the Covid-19 Vaccine?

**You have a choice.**  
*No government agency, organization, doctor, or even a Rav can force a medical intervention upon you.*

- 1. Is there a need altogether?** Although COVID is a serious infection, according to the CDC the actual chance of death for a healthy individual (even without any treatment) is very low.
- 2. There ARE preventions and cures.** There are safe, proven medications to prevent COVID, which are *more effective than the vaccine*. Once-a-week Ivermectin is almost 100 percent effective at preventing COVID. See <https://covid19criticalcare.com>. HCQ and Ivermectin also have a *sure rate for COVID of almost 100 percent*.
- 3. The shot does not prevent transmission.** According to Geert Vanden Bossche, DMV, Ph.D. from the GAVI Vaccine Alliance and many other scientists, the shot will not prevent you from spreading COVID to others. The vaccine companies as well as the FDA explicitly write that they have no evidence that the vaccines will prevent asymptomatic infection and transmission.
- 4. This shot is NOT FDA-approved.** It is an experimental injection only given Emergency Authorization. It is still in trial.
- 5. The vaccine companies are not liable.** If you get ill or die as a result of taking this injection, you cannot sue the manufacturer for damages. They are immune from liability according to the PREP act and the National Childhood Vaccine Injury Act of 1986.
- 6. Thousands of reported deaths and injuries.** Although the CDC denies causation, there have been thousands of reported deaths and injuries within days - and sometimes immediately - after receiving these injections. These numbers can be viewed at the government's VAERS website. *How many more korbanos do we need?*
- 7. Shochad Y'aver Pikchim.** The local healthcare organizations in each community are receiving MILLIONS of dollars from the Federal government under the CARES Act, to push the COVID vaccine on the local residents. If you feel a certain pressure and coercion, money may just be the reason why.
- 8. Shev V'al Ta'aseh.** Numerous scientists, virologists and doctors around the world are of the opinion that the COVID vaccines have the potential to cause great harm. The Peleh Yo'etz states that even if 99% of doctors say a medication or treatment is safe and only 1% of doctors say it is dangerous and life-threatening to use it, one would have to be a fool not to abstain. *Shev v'al ta'aseh adif.*
- 9. Trust someone who researched both sides.** If you are still unsure, speak to someone who has specifically researched the science, safety, and need for this injection and determines that it's right specifically for you. Just because you trust your Rav or doctor, that doesn't mean they are well-versed in this specific area. Only trust information from someone who carefully researched both sides. If your Rav or doctor refuses to hear you out, find someone else to ask. As Rav Elya Ber Wachtfogel shlit"z said, the only Rabbonim who promote the injection are ones who did not hear out both sides.

0-19: 99.9977%	50-69: 99.93%
20-49: 99.98%	70+: 94.6%

## דעת תורה

### אודות הוואקסין נגד קורונה

הנגו להודיע לציבור יראי ה' מבקשי האמת די בכל אתר ואתר כי אחרי בירור מקיף ע"י מרן גדולי ישראל, ובתוכם כ"ק מרן **אדמו"ר מאמשנינוב** בארה"ק מרן הגב"ר **אליהו דוב וואכטפויגל** ר"י זכרון משה סט. פאולסבורג מרן הגב"ר **מלכיאל קוטלער** ר"י לייקווד מרן הגב"ר **שמואל קאמינצקי** ר"י פילדלפיה האגון ר' **שמואל מאיר כ"ץ** דומ"ץ לייקווד ועוד הרבה מגדרי ומומחים גדולים שכירו חורד של הרבה רופאים בכל העולם משני הצדדים והתברר:

### יש בוואקסין לקורונה חששות של מזימות שפילות וסכנות חמורות ונוראות בכמה וכמה אופנים ח"ו!

**חזיב גדול לפעול ולהפעיל בכל היכולת למנוע סכנה נוראה זו ממתנה ישראל!**

**בימים אלו שהמורמים ממזרים הן תועמות ומשדדים את בעלי העיתונים וחצרות רבנים באר"י ובארה"ב בתעמולה גדולה לפתות הציבור לזה, לא ישנה את דעת התורה וההלכה המקובלת בזה!**

**לזו חכמו ישיבילו ויבינו שמוכשול חמור זה יגרור לחורבן ש"י פירודים ומחלוקת בפרט בעיני שידוכים ח"ו דה"ש!**

וכבר חזר כל גדולי ישראל ברוב העבר לא להגדר אתר דרכי רפואה חדשים שלא נוסו ועברו ניסויים על בני אדם או החולים ח"ו, ובזכות סנקיים מצות "ונשמרתם מאד לנפשותיכם" כהלכתה נוכח שיתקיים בנו הכתוב והסיריחי מוחלה מקרבך עדי נזכה בקרבן לכיאת נוא"צ בבי"א.

**"היהדות החרדית"**





*“If you connect the measles it spells out ‘My parents are idiots.’”*



**סכנה!**

**בורות בכביש**

**danger! ignorance on the road**

**خطرا! حفر في الطريق**

# Antivaxxers and Anti-Semitism

**From anti-vaxxers to antisemitism:**  
Conspiracy theory in the  
COVID-19 pandemic

*October 2020*

A new badge has been created which will allow you to go back to work, to travel in your state, to fly, catch a train or bus, and to buy and sell.

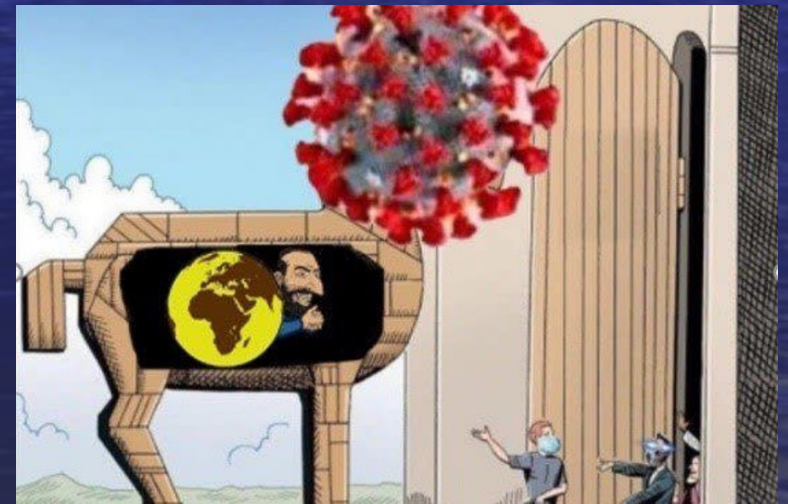
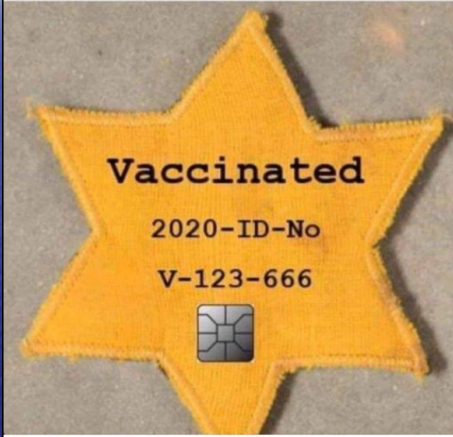

March 15, 2020 coronavirus is presented as a trojan horse for "globalist" Jews

Report: Pandemic inflames Jew-hatred, tropes

Posted April 15, 2021



# Opposition to Vaccination



*The Cow Pock — or — the Wonderful Effects of the New Inoculation! — vide the Publications of the Anti-Vaccine Society*

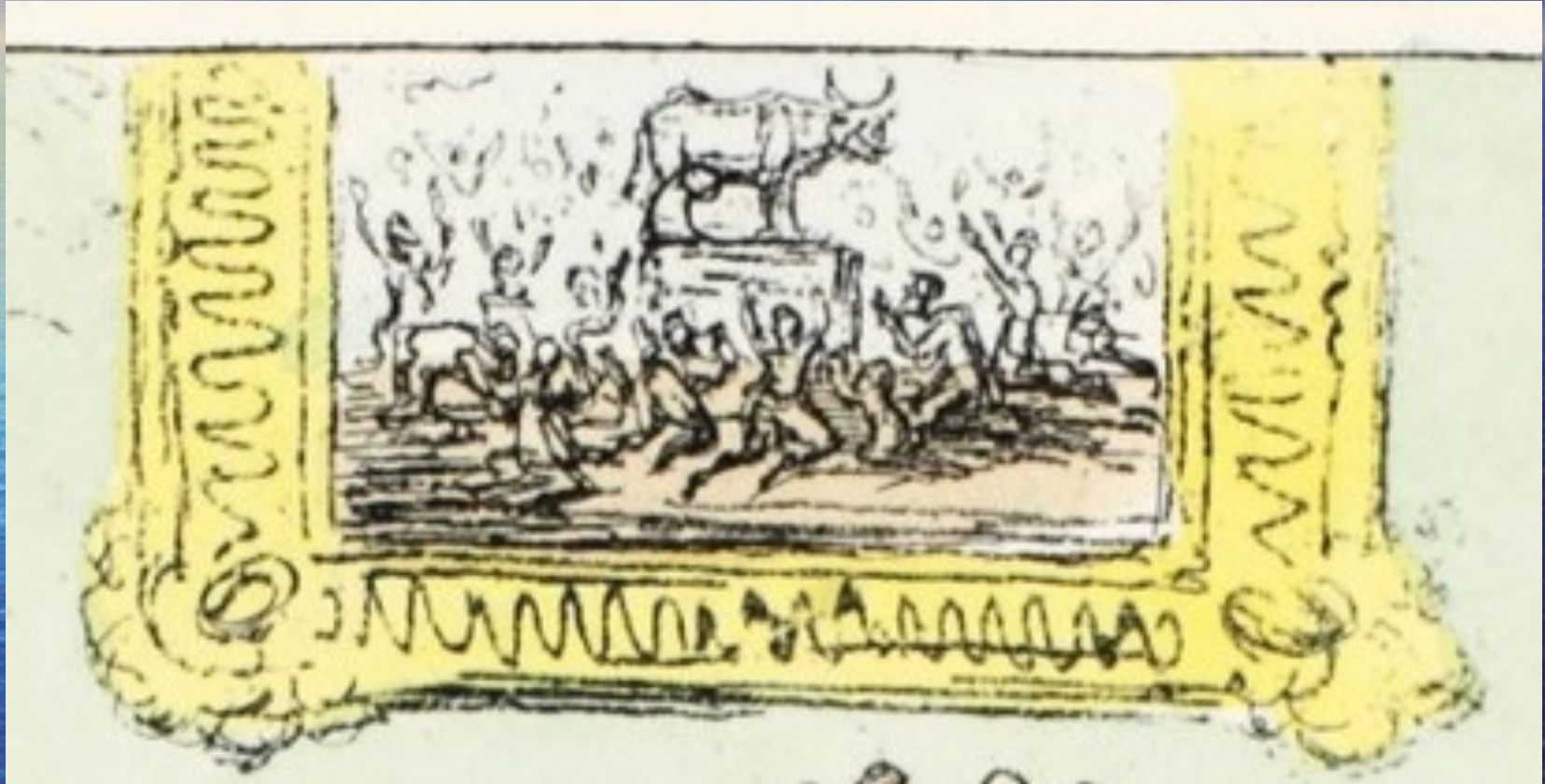

# Vaccination and Anti-Semitism



German satire attacking the Jews for supporting vaccination  
(1799)

discussed in "Modern Medicine Indicted:  
Anti-Jewish Iconography and Jenner's Smallpox Vaccine"  
Dr. Lisa R. Epstein (unpublished)

# Bar Mitzvah Drasha from Menachos 2017 Montreal

## Mitzvas Tefillin for Conjoined Twins

תלמוד בבלי מסכת מנחות דף לו עמוד א

בעא מיניה פלימו מרבי: מי שיש לו שני ראשים באיזה מהן מניח תפילין? א"ל: או קום גלי או קבל עלך שמתא. אדחכי אתא ההוא גברא, א"ל: איתיליד לי ינוקא דאית ליה תרי רישי, כמה בעינן למיתב לכהן?

### 2-headed baby born in Indonesia

**Tue, Jul 28, 2009**

A TWO-HEADED male infant has been born with a single, undivided body in Indonesia, reported Malaysian news agency Bernama. When news of the baby's birth broke, locals packed the hospital, eager for the chance to catch a glimpse of the baby.

The infant - who was delivered by a caesarean birth - also has a body with two arms, two legs, one pair of kidneys, one pair of lungs and one



Photo: Jakarta-Post

Rabbi Meyer Blumenfeld, 1965



אתה'תפילין בתורה והמשנה עשר  
העשרה א"ל עשו ונגזרתי האמת והצדק  
נוסם נדום, נשן, נזקלן

## איש עם שני ראשים

### דרוש להגינת בר-מצוה

ונקבצו בני יהודה ובני ישראל יהדו ושמו להם ראש אחד ועלו מן הארץ כי גדול יום יורעאל, (הפסוק).

בילקום (פ' במדבר) מוכא: בעא מיניה פלימו מרבי, מי שיש לו שני ראשין באיזה מהם מניח תפילין, אמר ליה קום גלי או קבל עלך שמתא, (רבי חשב שאין כמציאות שאדם יהיה עם שני ראשים), אדחכי והכי אתא ההוא גברא דאתיליד ליה ינוקא בתרי ראשי, אמר ליה כמה בעינן מיתב לכהן, אתא ההוא סבא, תנא ליה חייב ליתן עשר סלעים — דכגלגולת תלה רחמנא.



# Looking Forward to TIM'S Wedding

